



# ***Powersplit***

***Powersplit***



## Plug-in & PowerSplit



## Main features...

**-PowerSplit**

**-MasterCella Split**

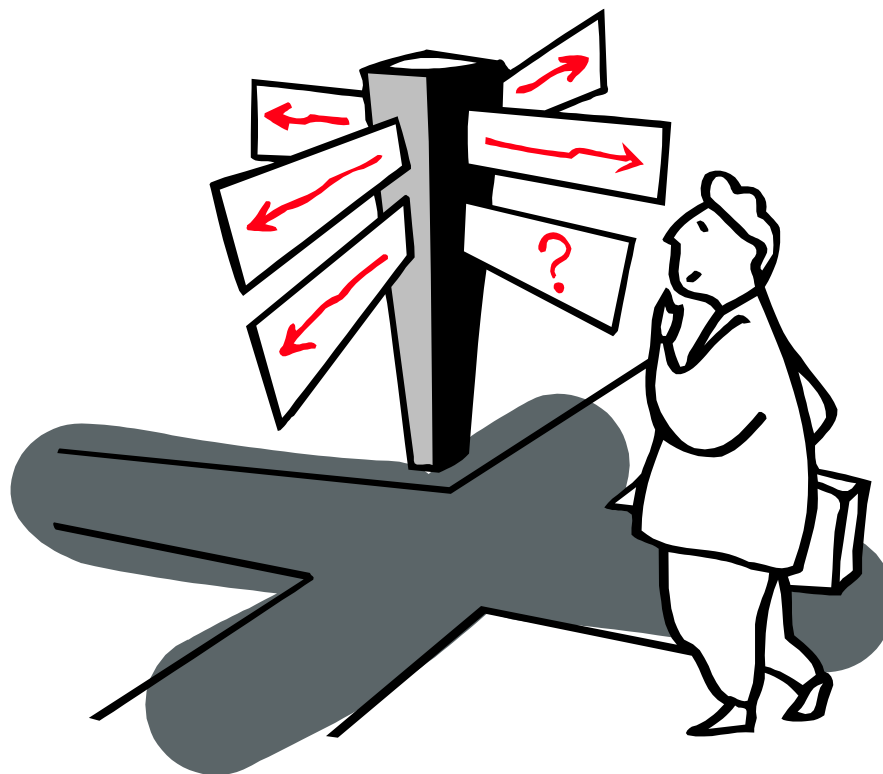



# PowerSplit: main features

- Real Time Clock
- 2Hp** compressor relay
- 3 NTC probes
- 2 evaporators defrost management
- 2 auxiliary programmable outputs
- Programming key
- LAN to synchronise defrost
- HACCP

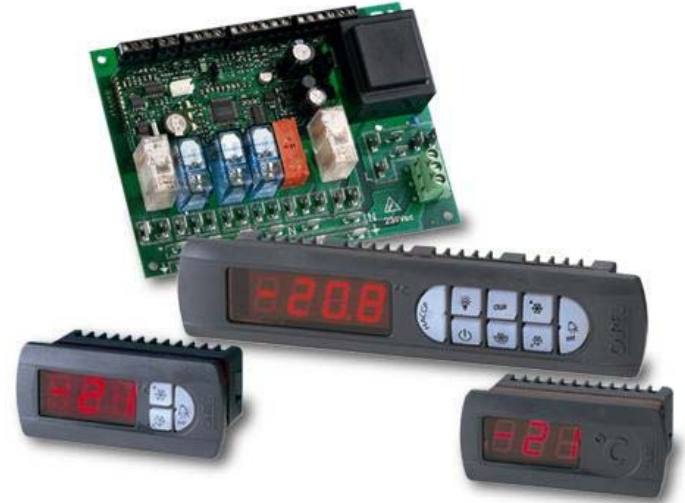



# Typical applications: Catering Equipment

## Plug-in & PowerSplit





# Typical applications: Cabinets

## Multiplexed stand alone units



## Synchronised defrost



# MasterCella Split: main features

- Real Time Clock
- 2Hp compressor relay
- 3 NTC probes
- Programming key
- 2 auxiliary programmable outputs
- 2 evaporators defrost management
- Alarm and condenser fan management
- Pump down management
- HACCP



# Plug-in range

Performance

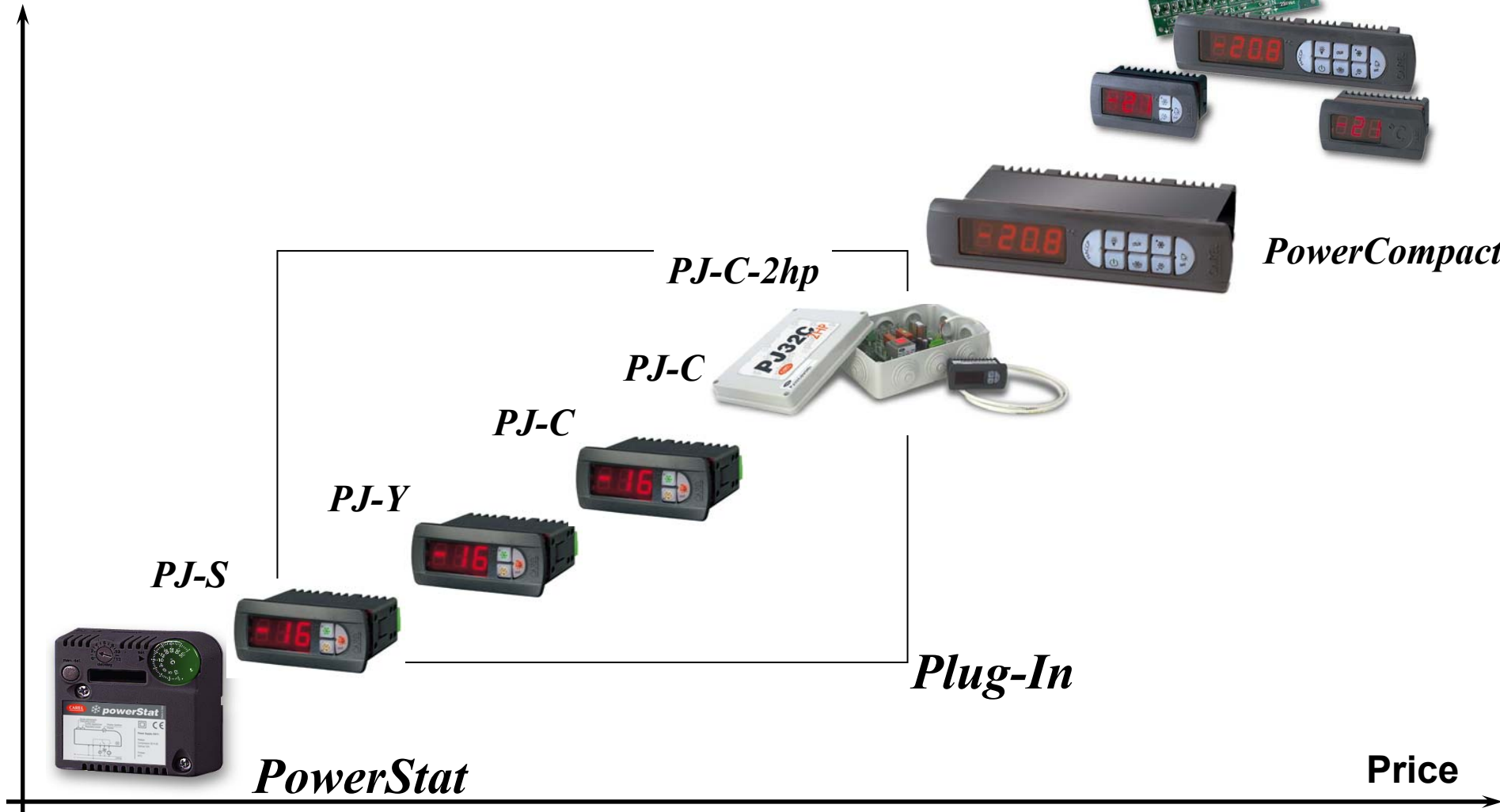

*Plug-in range*

CAREL



# PowerSplit display interfaces

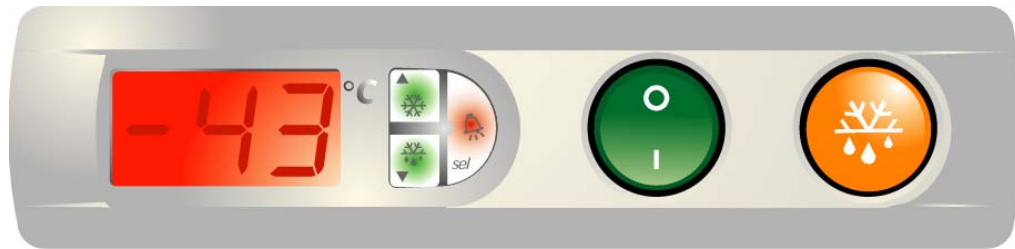



# A complete range of displays

## Compact version

- 36x81x42mm (minimum housing depth: 35mm)
- 3 LED's display (Plug-in family feeling)
- 3 buttons backlit : compressor On, Alarm, defrost





# A complete range of displays

## Large frame compatible

- possibility to add 2 on-off switches

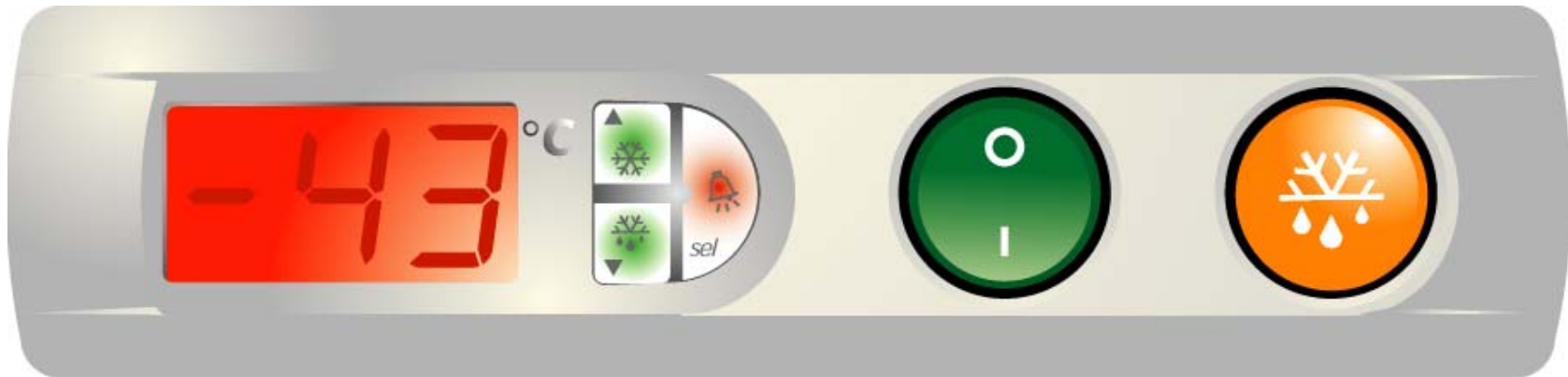



# A complete range of displays

## Multi-functions display interface

- LED display & 8 backlit buttons
- HACCP functions
- 30mm minimum housing depth





# HACCP functions

- High temperature, power failure
- HACCP button:
  - Display details on critical alarm events
  - Direct Haccp alarm reset access





# PowerSplit: programming key

## Parameter settings:

it works without power supply  
(battery inside)

- ... download from the key
- ... or upload to the key
- a LED turns from **red** to **green**  
when OK





# PowerSplit: the first control with **optical sensor**

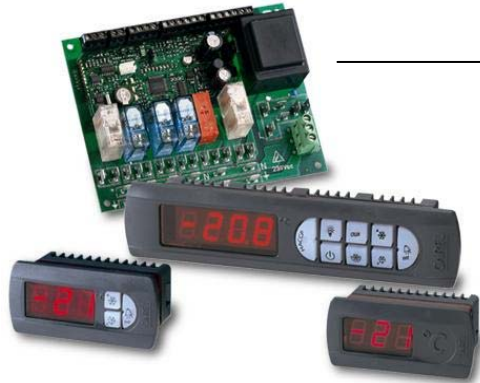

# PowerSplit: connections

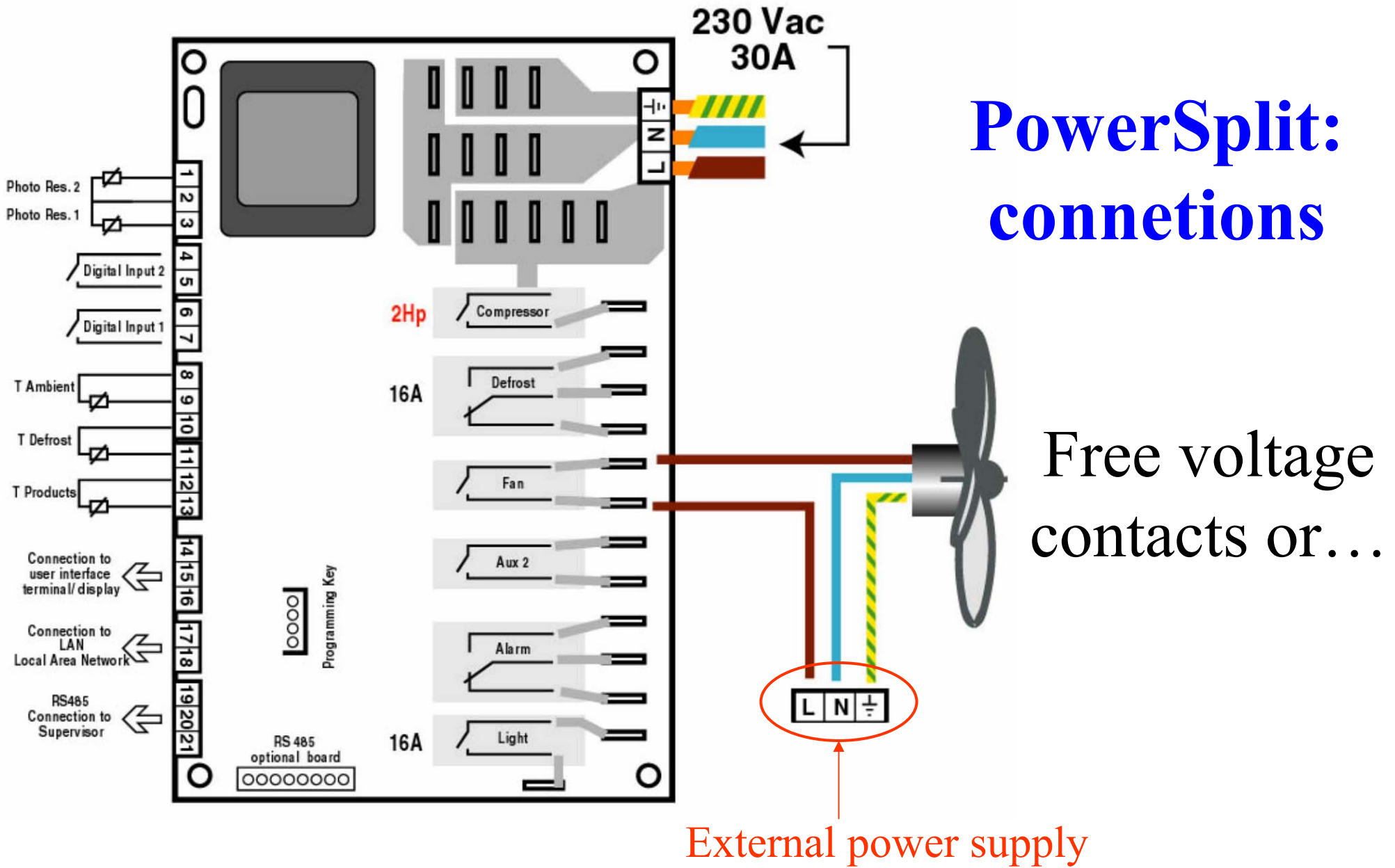

Free voltage contacts or...

# PowerSplit: connections

...directly on the  
board.

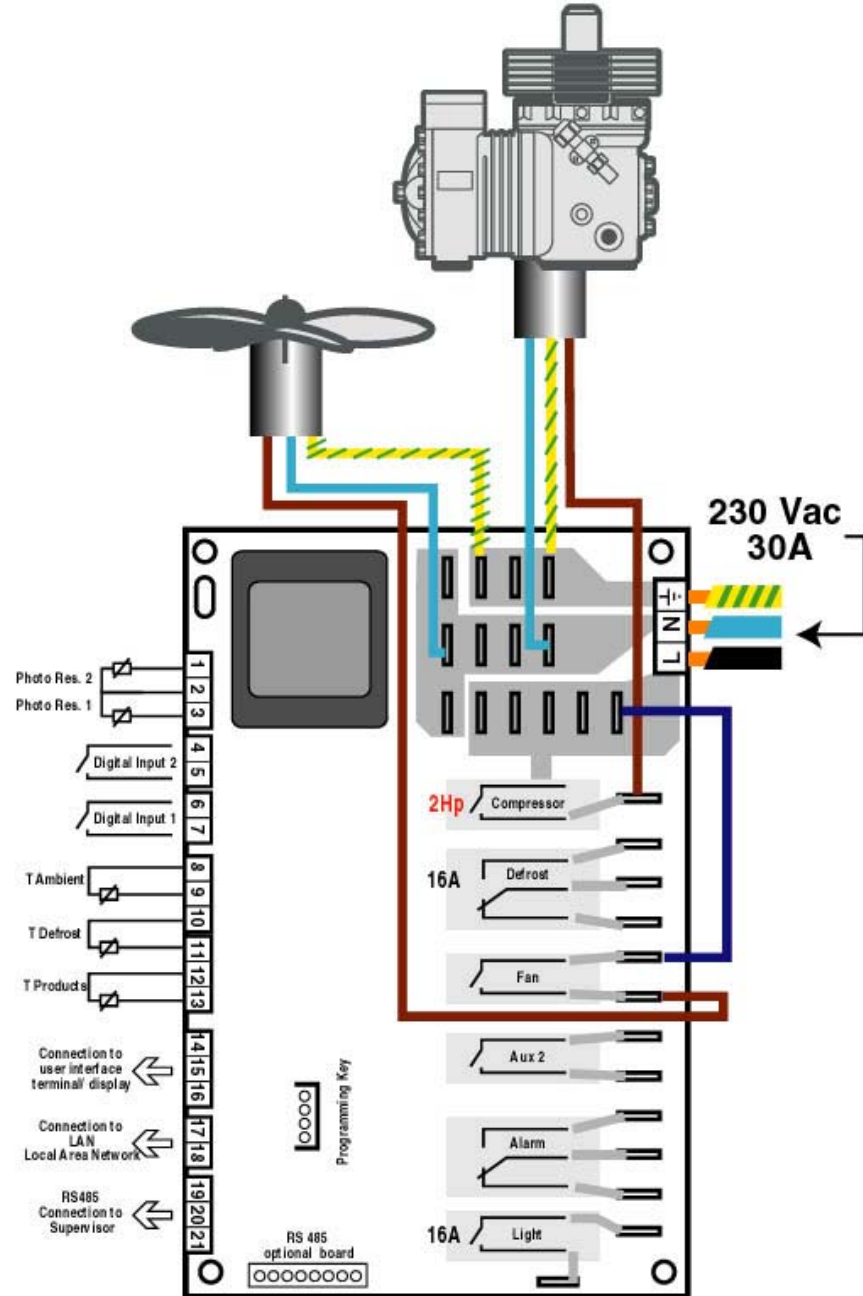



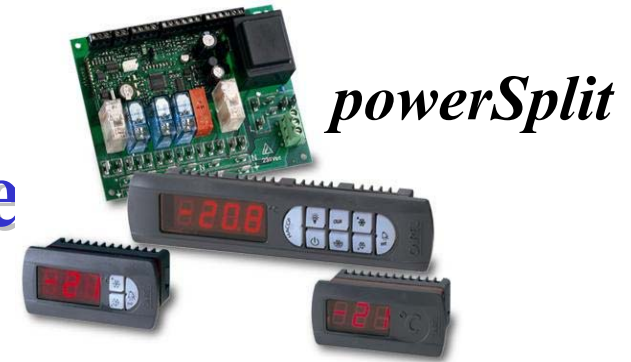























# Power Split:Low Temperature ventilated

4,6 outputs range

- PSB0000000     **2hp**, 16A, 8A, 8A, 3 NTC
- PSB0001000      **2hp**, 16A, 8A, 8A, 3 NTC
- PSB0000100       **2hp**, 16A, 8A, 8A, 16A, 8A  
3 NTC
- PSB0001100        **2hp**, 16A, 8A, 8A, 16A, 8A  
3 NTC

All models 230 V

# Power Split Vs Others

**powerSplit**



**Dixell Wing**



**LAE SMD-90**



**Eliwell Power Frost**



**PLUS**

**Yes**

**Haccp**

**No**

**No**

**No**

**Yes**

**2 hp**

**No (20A)**

**No**

**No (30A)**

**Yes**

**LAN**

**No**

**No**

**No**

**Yes**

**Light sensor**

**No**

**No**

**No**

**Yes**

**Removable frame**

**No**

**No**

**No**



# Power Split



## Documentation & Brochures

- Leaflet: 6 languages** 
- Technical manual: 2 languages** 
- Brochures: 2 languages** 
- All the documentation on PDF format**



# Power Line: some customers





[www.carel.com](http://www.carel.com)